



# 126 SERIES TPL



Big flow and reduced drop pressure.  
Available only without valve, free flow

### • Materials

Carbon Steel EN -10277-3, AISI316, Brass DIN-EN 12164

Seals: *Viton*

Balls: *As version*

Springs: *As version*

### • Working temperature (Seals)

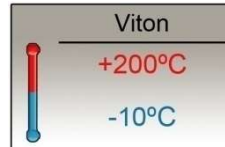

• **Applications:** Designed for Oil and Hot Water. Applications according to European Directive 97.23.EC

• **Sectors:** High pressure cleaning systems

### • Equivalence

3/8" TEMA 3800  
KEW



## MODEL STRUCTURE

Example:

# 126.12022 AC

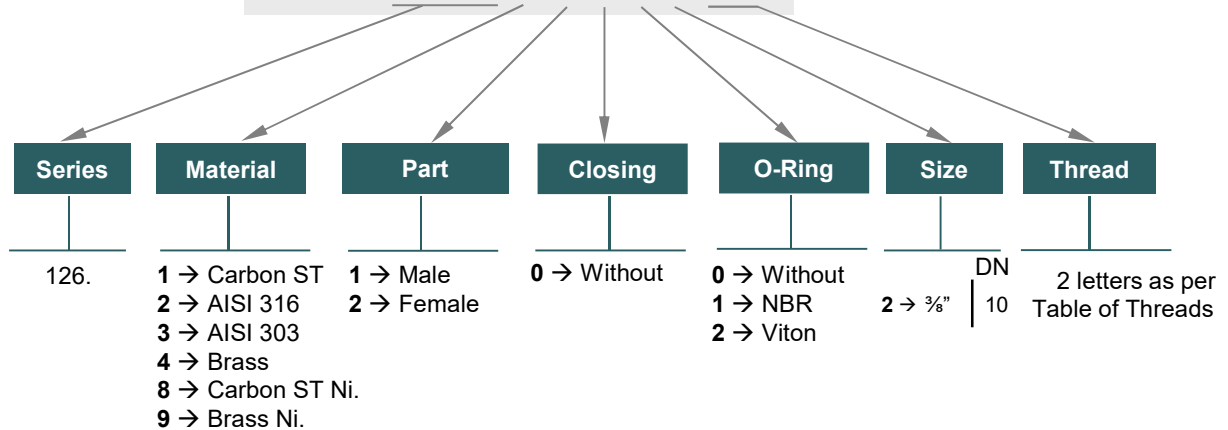

126-1



# 126 SERIES TPL

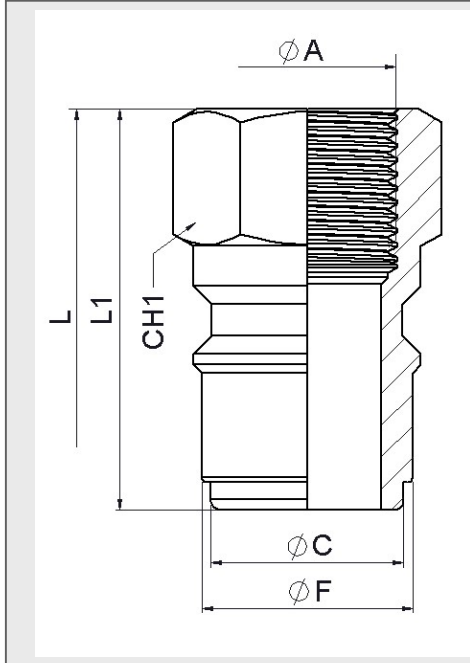

MALE									
DN	CH1	L1	ØF	ØC	L	MATERIAL	REF.	ØA	
12	22	38	19,90	18,25	58	White zinc plated steel	126.11002AC	3/8" BSP	600 Bar
							126.11002BC	3/8" NPTF	
						Nickel plated steel	126.81002AC	3/8" BSP	600 Bar
							126.81002BC	3/8" NPTF	
AISI 316	126.21002AC	3/8" BSP	350 Bar						
	126.21002BC	3/8" NPTF							
14	27	48	19,90	18,25	68	White zinc plated steel	126.11002AD	1/2" BSP	600 Bar
							126.11002BD	1/2" NPTF	
						Nickel plated steel	126.81002AD	1/2" BSP	600 Bar
							126.81002BD	1/2" NPTF	
						AISI 316	126.21002AD	1/2" BSP	350 Bar
							126.21002BD	1/2" NPTF	

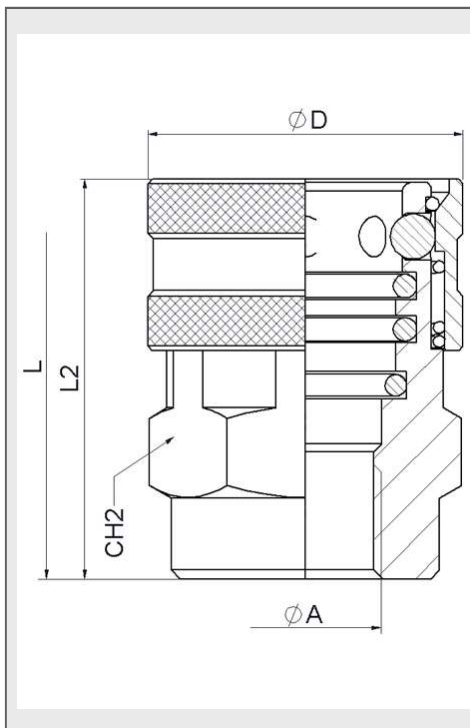

FEMALE								
DN	CH2	L2	ØD	L	MATERIAL	REF.	ØA	
12	30	44	35	58	White zinc plated steel	126.12012AC	3/8" BSP	600 Bar
						126.12012BC	3/8" NPTF	
					Nickel plated steel	126.82012AC	3/8" BSP	600 Bar
						126.82012BC	3/8" NPTF	
					Brass - Viton	126.42022AC	3/8" BSP	350 Bar
						126.42022BC	3/8" NPTF	
Nickel plated brass	126.92022AC	3/8" BSP	350 Bar					
	126.92022BC	3/8" NPTF						
AISI316	126.22022AC	3/8" BSP	500 Bar					
	126.22022BC	3/8" NPTF						
14	30	44	35	68	White zinc plated steel	126.12012AD	1/2" BSP	600 Bar
						126.12012BD	1/2" NPTF	
					Nickel plated steel	126.82012AD	1/2" BSP	600 Bar
						126.82012BD	1/2" NPTF	
					Brass - Viton	126.42022AD	1/2" BSP	350 Bar
						126.42022BD	1/2" NPTF	
Nickel plated brass	126.92022AD	1/2" BSP	350 Bar					
	126.92022BD	1/2" NPTF						
AISI316	126.22022AD	1/2" BSP	500 Bar					
	126.22022BD	1/2" NPTF						



# 126 SERIES TPL

PLUGS  
& CAPS





TPL SERIES PLUGS/ CAPS have been designed to protect FEMALE (coupler) or MALE (nipple) parts while they are disconnected.

Example:

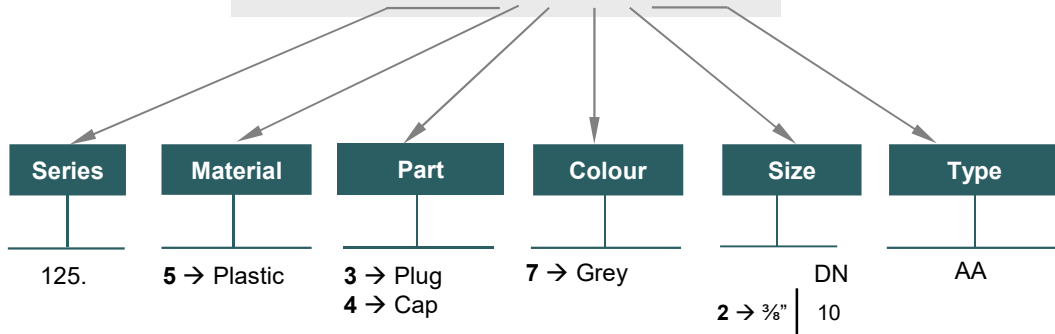
## 125.5372 AA



Plug for Female Part			
REF.	Part	DN	Colour
125.5372AA	Plug	10	Grey

Cap for Male Part			
REF.	Part	DN	Colour
125.5472AA	Cap	10	Grey