

SD 1 Operating Instructions



KRACHT
Volutronic®

1. SAFETY	3
2. DESCRIPTION	4
3. CONNECTING THE SD1	5
3.1 Connecting the voltage supply	5
3.2 Connecting SD1 with rectangular output.	5
3.3 Connecting the SD1 with analog output	6
3.4 Connecting the SD1 with relay contacts.	7
3.5 How is the flow rate measurement activated ?	8
3.6 How is the volume measurement activated ?	9
3.7 Error display	10
4. SD1 PROGRAMMING	11
4.1 Overview of the input values	12
4.2 What must be programmed when connecting a volume counter?	13
4.3 How to change time on flow display ?	15
4.4 How to find out the flow rate?	16
4.5 What must be programmed when connecting the relay outputs ?	17
4.6 What must be programmed when connecting the analogue output ?	18
5. TECHNICAL DATA	19
6. TYPE CODE	20
7. CONNECTIONS	21

1. Safety



The safety notes included in these operating instructions are indicated by this 'attention-getter' symbol.

If the text accompanying this symbol is not heeded, danger to personnel or equipment may result.



Other instructions, which are not safety warnings, but which give advice on optimum operation, are indicated by a hand.

General safety instructions

The electronic SD1 is constructed to the latest standards in technology. The SD1 should be operated only

- in technically sound condition,
- as instructed,
- with awareness of the safety precautions, following these operating instructions.

The SD1 must only be operated as an item of equipment installed in an internal area.

The SD1 must only be operated in the prescribed condition.

The stated limiting values (see also section on "Technical Data") must, under no circumstances, be exceeded.

Personnel engaged in the installation, operation and maintenance of the SD1 must be appropriately qualified. This qualification can be obtained by appropriate training or instruction. Such personnel must be familiar with the contents of these operating instructions.



During all operations the relevant national regulations relating to safety precautions in the work place and where applicable, internal regulations of the operator must be observed, even if these are not detailed in these operating instructions.



The SD1 must not be operated in hazardous areas, nor in areas where medical apparatus is in use, nor in areas which are expressly named in VDE 0411 Part 100.



If the SD1 is used for the control of machines or sequential processes where damage to the machine or accident to operating personnel is possible as a consequence of failure or faulty operation of the SD1, then appropriate safety precautions must be implemented.



In the case of variations (including those relating to operating behaviour), which prejudice safety, the SD1 must be switched off immediately.



During installation work on the SD1, the power supply must always be disconnected. Installation work must only be carried out by appropriately qualified personnel.

2. Description

The plug-in display unit SD 1 may be used with any KRACHT volume counter which uses a plug-in connection according to DIN 43650.

The display unit is simply inserted between the plug and the plug socket on the volume counter. The displayed value will be the actual flow rate. The square wave signals remains available for external processing.

Volume counters already supplied can be equipped with the plug-in display unit. To achieve this the amplifier card must be removed from the plug socket.

The plug-in display unit is freely programmable. All necessary settings can be achieved with two keys. The programmed data is stored on an EEPROM and therefore saved in case of power failure.

As an option the plug-in display is available with an analogue output (0-20 mA, 4-20 mA) proportional to flow rate. The square wave signal is then not applicable.

The plug-in display unit works with 24 VDC or 12 VAC.

Due to it's characteristics, possibilities and low costs this instrument will be your first choice especially for measuring of flow and volume.

Manufacturers address:

KRACHT GmbH
Gewerbestraße 20
58791 Werdohl

Tel. 02392 / 935-0
Fax 02392 / 935209

3. Connecting the SD1

This section deals with the layout of the connections on the SD1. The electrical connection has to be made by a plug-in connection acc. to DIN 43650.

3.1 Connecting the voltage supply

The SD1 is operated with an voltage of 24 VDC or 12 VDC. The adjustment is achieved by means of solder jumpers.

The connections are made as follows :

Terminal 1	+24 VDC	(brown)
Terminal 2	GND	(white)

3.2 Connecting SD1 with rectangular output.

The SD 1 is available in three versions:

- SD1 – R with two rectangular signals with a pulse offset of 90°.
- SD1 – I with analog output (0-20 mA/4-20 mA)
- SD1 – K with relay contact

Connections are different in each version.

Option with rectangular output:

Connection of rectangular output has to be made on clamps.

Terminal 3	Channel 1	(green)
Terminal 	Channel 2	(yellow)

If the SD1 works with a volume counter, which has 2 sensors, it is a 2-channel version. The square wave pulses are displaced from one another by 90°. It is therefore possible to detect the direction. This is referred to as a two channel layout. If the SD 1 works with a volume counter, which has only 1 sensor, it is a 1-channel version. Connection on clamp  (channel 2) is not necessary.



Single channel or two channel connection must be set on the SD1. The settings required are made under menu reference „08“ at the “**counter input**” position (see **4.1 overview of the input values**).

3.3 Connecting the SD1 with analog output

The SD1 is available in 3 versions

- SD1-R with two rectangular signals with a pulse offset of 90°,
- **SD1-I** with analog output (0-20 mA/4-20 mA),
- SD1-K with relay contact.

Connections are different in every serial-model modification.

Option with analog output (0-20mA/4-20 mA):

Connection of analog output has to be made on clamps.

Terminal 3	Analog Output (+)	(green)
Terminal 2	GND	(white)



In accordance with the software, the settings 0-20 mA and 4-20 mA are available for signal selection. The selection is carried out by programming the SD1 under menu reference “8” at the “**Analogue output**” position. The functions are set using “0” or “1” (see **4.1 Overview of the input values**).

How does the analogue output function ?

The function of the analogue output can be freely selected, i.e. it can be assigned to the measurement parameters of flow rate or volume.



For adjusting volume-/flow measurement please see chapter **3.5 and 3.6**.

A maximum value can be programmed for the analogue output. The maximum value corresponds to an output of 20 mA.



The details of programming the maximum value are given in **section 4.6**
What must be programmed when connecting the analogue output ?

3.4 Connecting the SD1 with relay contacts.

The SD1 is available in 3 models:

- SD1-R with two rectangular signals with a pulse offset of 90°,
- SD1-I with analog output (0-20 mA/4-20 mA),
- **SD1-K** with relay contact.

Connections are different in every serial-model modification.

Option with relay contact:

The SD1 has two relay contacts. The relay contacts are connected to the supply potential. That means the contacts switch the supply voltage to external processing. Connection has to be made on clamps.



The relays are provided with normally-open contacts. The switching voltage is 30 V, maximum switching current is 1A.

Connection of relay contact has to be made on clamps.

Terminal 3	Relay 1 (green)
Terminal 	Relay 2 (yellow)

How do the relays operate ?

The function of the relays can be set as required, i.e. each relay can be allocated to the flow rate or volume measurement parameters.

An on and an off switching value can be programmed for each relay. The relay switches when the switch-on value is exceeded. When the switch-off value is undershot, the relay drops out again. The relays can be programmed as normally-open or normally-closed.



The programming of the switch-on and switch-off values is given in **section 4.5 What must be programmed when connecting the relay outputs?**.

Wird das SD1 in der Betriebsart Volumenmessung betrieben, entfällt das Relais 2.



For adjusting volume and flow measurement please see chapter **3.5 and 3.6**.

3.5 How is the flow rate measurement activated ?



The SD1 can be switched to flow measurement or volume measurement. This will be made by programming SD1 under menu “7” at step “**display**”. The flow rate will be adjusted by “0” and the volume by “1”. (see 4.1 for overview of input values).

As soon as a medium flows through the volume counter a flow rate indication appears. No special action is required. The instantaneous flow rate is indicated, as a rule in litres per minute.



The SD1 must be adjusted to the actual volume counter that is connected. The procedure is given in **section 4.2 What must be programmed when connecting a volume counter?**

3.6 How is the volume measurement activated ?



The SD1 can be switched to flow measurement or volume measurement. This will be made by programming SD1 under menu "7" at step "display". The flow rate will be adjusted by "0" and the volume by "1". (see 4.1 for overview of input values).

By volumetric measurement is implied the summation of the amount of a medium which has flowed through a volume counter. As a rule the indication is in litres.



When the limiting frequency has been passed and a release signal has been given a summation will be made. To programm limiting frequency under menu "10" you have to take the volume counter's impulse frequency in hertz (Hz). Usually the limiting frequency has to be set to 0.000.

Connection of release signal output has to be made on clamps:

Terminal 	summation enable	(yellow)
--	------------------	----------



If there is a voltage of 24 V at the enable input, summation of the volume commences. The measured values on the display change.

If there is a voltage of 0 V at the enable input, summation of the volume is stopped. The measured values on the display do not change.

When the voltage at the enable input is changed from 0 V to 24 V the summation is reset to zero. The determination of the volume starts again.

3.7 Error display

On two channel volume counters it is possible to monitor the correct pulse sequence on the channels. Faulty pulses are not counted and thus do not change the volume measurement.

If an error is established by the SD1, the character sequence "**FAUL**" appears in the display.



The error display can also be completely isolated. This is carried out under the menu reference "**08**" at the "**counter input**" position. The error display is enabled with a "**0**" and blocked with a "**1**" (see **4.1 Overview of the input values**).

4. SD1 programming

Each time the SD1 is to be operated, it is necessary to adapt the unit to the volume counter that is connected.

Input procedure:

The input procedure is the same for all input values and is therefore described once only. Programming is carried out by means of two keys which are accessible on removing the front cover. The positions of these two keys is shown below.

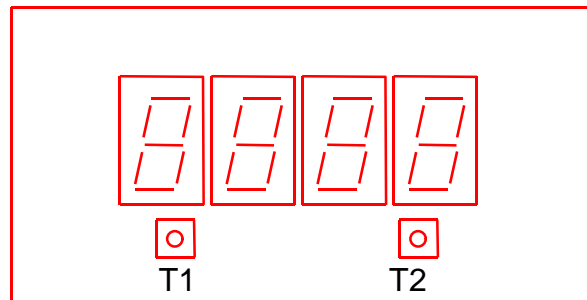

Start input operation

“T1“ and „T2“ are depressed for approx. four seconds to start the input operation. The first two segments are switched dark, segments three and four display the menu reference number ”00“. Release “T1“ and „T2“.

Change menu reference

By briefly pressing “T1“ the menu reference numbers “00” to “10” can be displayed in sequence.

An input value is concealed behind each menu reference number.

To display the input value, press “T2” briefly. A four digit input value appears.

Change input value

The point marks the digit which can be changed by actuating “T2”.

The point can be moved by actuating “T1“.

After setting the numerical values the point must be placed at the correct position.



On actuating “T1” and “T2”, the display reverts to the menu-reference level. The menu reference “00” is displayed again.

Stop input value

To exit the input operation, depress “T1” and “T2”. again for approx. four seconds.

4.1 Overview of the input values

The values which are required to be set can be inserted in the column labelled “Input value-User”.

Menu – Reference	Input value - User	Standard setting	Function	Unit
00		0.040	Pulse volume of volume counter	ml
01		3.500	Maximum value Analogue output	l/m
02		0.400	Damping Digital filter or gate time in seconds	1
03		9999.	“Pull-in” value Relay 1	l/m
04		9999.	“Drop-out” value Relay 1	l/m
05		9999.	“Pull-in” value Relay 2	l/m
06		9999.	“Drop-out” value Relay 2	l/m
07		0000	 <p>Time base: 0 = Minute 1 = Alternative time base</p> <p>Alternativ time base:0 = Second 1 = Hour</p> <p>Display: 0 = Flow rate 1 = Volume</p> <p>Measurement: 0 = Gate time 1 = Period measurement</p>	
08		0000	 <p>Counter input : 0 = 2 channel 1 = 1 channel</p> <p>Display: 0 = Normal 1 = 180° Rotation</p> <p>Analog/Relay:: 0 = Analogue output 1 = Relays</p> <p>Analogue output 0 = 0-20mA 1 = 4-20 mA</p>	
09		1.000	Density	Kg/l
10		0.000	Limiting frequency	Hz

If the on and off values for the relays are set at 9999. , then the relays are isolated.

4.2 What must be programmed when connecting a volume counter?

The SD1 is set-up for the connected volume counter. This is carried out under menu reference “00 - pulse volume counter”, menu reference “09 - density”, and under menu reference “08” at the position “counter input”.

The pulse volumes for KRACHT Volume counters can be obtained from the Table. The “X” characters in the “Input value Menu reference 08” column are of no significance in setting the volume counter.

Designation	Material	Input value Menu reference 00	Input value Menu reference 08
VC 0,025	Sp. Gr. Iron*	0,025 cm ³	XXX0 2 channel
VC 0,04	Sp. Gr. Iron	0,040 cm ³	XXX0 2 channel
VC 0,2	Sp. Gr. Iron	0,245 cm ³	XXX0 2 channel
VC 0,4	Sp. Gr. Iron	0,400 cm ³	XXX0 2 channel
VC 1	Sp. Gr. Iron	1,036 cm ³	XXX0 2 channel
VC 3	Sp. Gr. Iron	3,000 cm ³	XXX0 2 channel
VC 5	Sp. Gr. Iron	5,222 cm ³	XXX0 2 channel
VC 10	Sp. Gr. Iron	10,48 cm ³	XXX0 2 channel
VCA 0,2	Aluminium	0,200 cm ³	XXX1 1 channel
VC 0,2 AL	Aluminium	0,245 cm ³	XXX0 2 channel
VCA 2	Aluminium	2,000 cm ³	XXX1 1 channel
VC 0,2 .JR	High grd. St.*	0,200 cm ³	XXX0 2 channel
VC 1 .JR	High grd. St.*	1,000 cm ³	XXX0 2 channel
VC 5 .JR	High grd. St.*	5,000 cm ³	XXX0 2 channel
VCL 0,1 PA(B)	High grd. St.*	0,100 cm ³	XXX0 2 channel
VCL 0,1 PG	High grd. St.*	0,100 cm ³	XXX1 1 channel

* Sp. Gr. Iron = Spheroidal graphite iron * High grd. St. = High grade steel

Example:

A VC0.04 volume counter is connected. The pulse volume is 0.040 cm³. The VC 0.04 Volume counter has a 2 channel layout.

- The value 0.040 is entered under menu reference “00”.
- A “0” is entered under menu reference “08” at the position designated “counter input”.

Additionally a density factor can be adjusted to indicate the mass. Density of medium will be adjusted under menu “09 – density factor”.

For volumetric measurement density factor has to be adjusted to “1.000”.

4.3 How to change time on flow display ?

You can choose between second, minute and hour to change time on flow display by adjusting menu **07**.

Setting the time base:

Time base	Input value Menu reference 07
-----------	----------------------------------

Minutes	XX00
Minutes	XX10
Seconds	XX01
Hours	XX11

The “X” characters in the “Input value Menu reference 07” column are of no significance in setting the time base.

4.4 How to find out the flow rate?

The SD1 commands two measuring systems to determine the flow:

- duration of period or measurement of pulse width and
- gate time.



You can choose between “gate time measurement” or “duration of period measurement” under menu **07**.

Duration of period :

With the measurement of the period duration the time between two pulses is measured and is processed with the pulse volume to the flow.



Input signals smaller than 1 Hz are not processed.

The measurement of period duration enables very fast measuring. If the flow values fluctuate greatly the digital damping filter makes a smoothing and thereby a calming of the flow indicating unit possible.

A digital filter can be activated under the menu reference “**02**”. The higher the input value the greater the filter effect.

Programmed value 0000:	no filter effect
Programmed value 9999:	maximum filter effect

Gate time measurement:

With the gating time measurement the pulses within a programmed gating time are counted and processed with the pulse volume to the flow.

Gate time can be adjusted under menu **02**. Adjustable minimum gate time is 0.1 second.

4.5 What must be programmed when connecting the relay outputs ?

Relay function can be adjusted only if the instrument was ordered with option relay contacts (SD1-K.). The relays can be allocated to flow rate or volume measurement.

Flow rate measurement

A “0” is inserted under the menu reference “07”. This takes place at the position designated “Display” (see 4.1 Overview of the input values).

Volumetric measurement

A “1” is inserted under the menu reference “07”. This takes place at the position designated “Display” (see 4.1 Overview of the input values).

Switch functions

For Relay 1, programming takes place under the menu references “03” and “04”, for Relay 2 under the menu references “05” and “06” (see 4.1 Overview of the input values).

The following switch functions can be obtained::

Normally-open function

On reaching the switch-on value the contact is closed.

Example: Switch-on value (pull-in): 2,500
Switch-off value (drop-out): 9999

The relay contact is switched when the switch-on value is exceeded. The switch-off value of **9999** has the consequence, that only the switch-on value is evaluated. The relay is not disconnected when the switch-off value is reached.

Normally-closed function

On reaching the switch-off value the contact is opened.

Example: Switch-on value: 0.000
Switch-off value: 3,000

The relay contact is switched so long as the switch-off value is not reached. The switch-on value of **0.000** has the consequence, that only the switch-off value is evaluated. The relay is not switched-off if the switch-on value is reached.

Window function

Example: Switch-on value: 2,500
Switch-off value: 3,000

Hystresis switch

The relay contact is switched when the switch-on value is reached. If the switch-off value is exceeded, the relay opens again.

Example: Switch-on value: 4.000
Switch-off value: 3.000

4.6 What must be programmed when connecting the analogue output ?

The analog output can be used only if the instrument was ordered with analog output (SD1-I...).

The analogue output can be assigned to flow rate or volume measurement.

Flow rate measurement

A “0” is inserted under the menu reference “07”. This takes place at the position designated “Display” (see 4.1 Overview of the input values).

Volumetric measurement

A “1” is inserted under the menu reference “07”. This takes place at the position designated “Display” (see 4.1 Overview of the input values).

Signal selection

Menu reference 08	Analogue output
0XXX	0 - 20 mA
1XXX	4 - 20 mA

The digits identified with an “X” in the Menu reference “08” column are of no significance to the setting procedure.

The maximum value is entered under the menu reference “01”, maximum analogue output, corresponding to an output of 10 V or 20 mA.

Example:

Maximum analogue output value: 3,500 [Litres / minute]

The flow rate is 3,500 Litres/minute, so 20 mA are output. If the flow rate is 0,000 Litres/minute, then 0 mA is output.

5. Technical Data

Processor	PIC 17C42
Power pack Supply Maximum input current	18 VDC – 28 VDC optional 10 – 19 VDC ca. 120 mA
General data	
Display	Principle : 7 Segment LED, 7,62 mm, red Display :0.000 ... 9999 with floating point overrun (>9999) : display 9999
Control keys	Two keys behind the front cover
Housing material	Aluminium
Dimension	Height (without plug) approx. 35mm, width approx. 60mm, depth approx. 60 mm
Protection class (DIN 40050)	IP 65
Weight	ca. 0,12 Kg
Connections	Angled connector DIN 43650 (4-pins) polarized
Analogue outputs (Option)	Current output 0 - 20 mA, 4 - 20 mA / load \leq 250 Ohm, 18-28 VDC power supply load \leq 50 Ohm bei 10 VDC power supply Resolution 10 bit, short-circuit proof
Pulse output	Incremental signal
Pulse amplitude	Approx. 0.8 x supply voltage, load dependent
Pulse shape with symm. Output signal	Square wave, pulse duty factor/channel 1:1, +/-15%
Pulse offset between two channels	90°, +/- 30 °
Output power/channel	max. 0,3 W short-circuit-proof
Relay contacts	each 1 N.O., 24 Volt / 1 A, typ. operating time 6 ms
Ambient conditions	
Operating temperature	0 C to + 60 °C
Storage temperature	-25 °C to +85 °C

6. Type code

Example :

SD1 - R - 24 / .

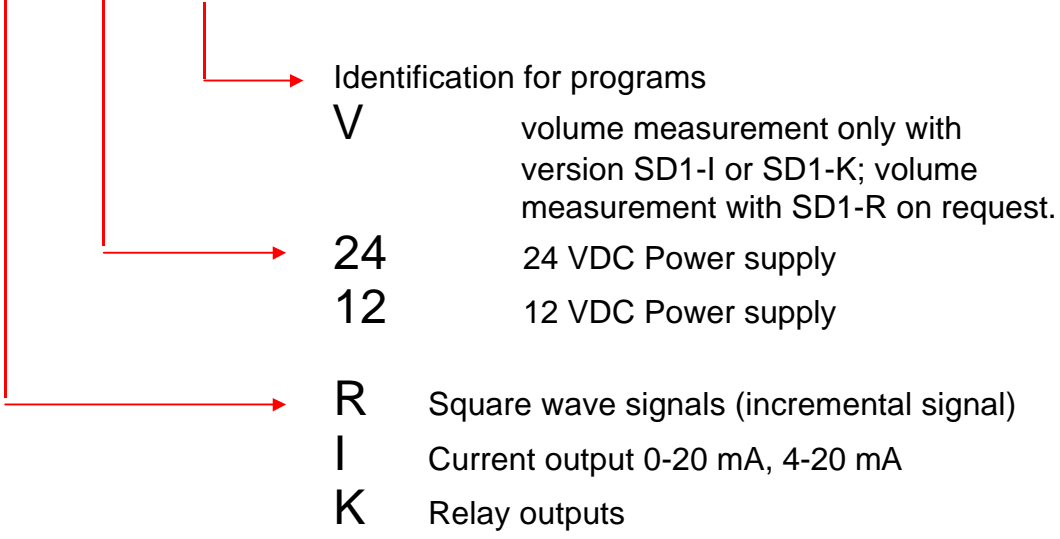

7. Connections

The electrical connections are made by a plug-connection DIN 43650

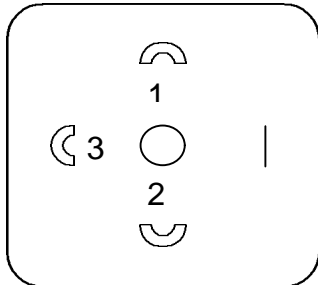

Connections Version SD1-R-24

PIN 1 = UB+
 PIN 2 = GND
 PIN 3 = Channel 1
 PIN  = Channel 2

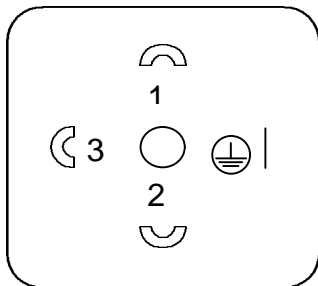

Connections Version SD1-I-24

PIN 1 = UB+
 PIN 2 = GND
 PIN 3 = Analogue output 0/4-20 mA
 PIN  = Enable summation

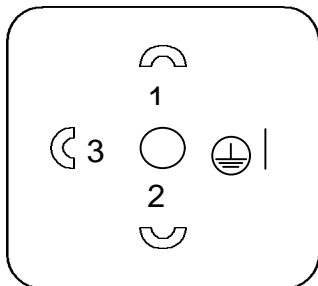

Connections Version SD1-I-24 / V

PIN 1 = UB+
 PIN 2 = GND
 PIN 3 = Analogue output 0/4-20 mA
 PIN  = Enable summation

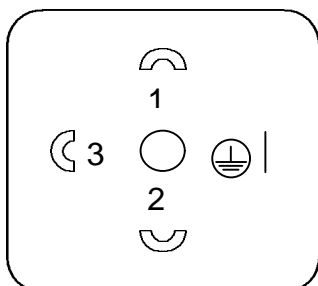

Connections Version SD1-K-24

PIN 1 = UB+
 PIN 2 = GND
 PIN 3 = Relay 1
 PIN  = Relay 2

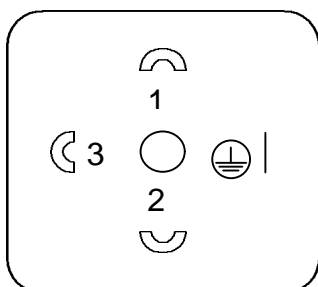

Connections Version SD1-K-24 / V

PIN 1 = UB+
 PIN 2 = GND
 PIN 3 = Relay 1
 PIN  = Enable summation